

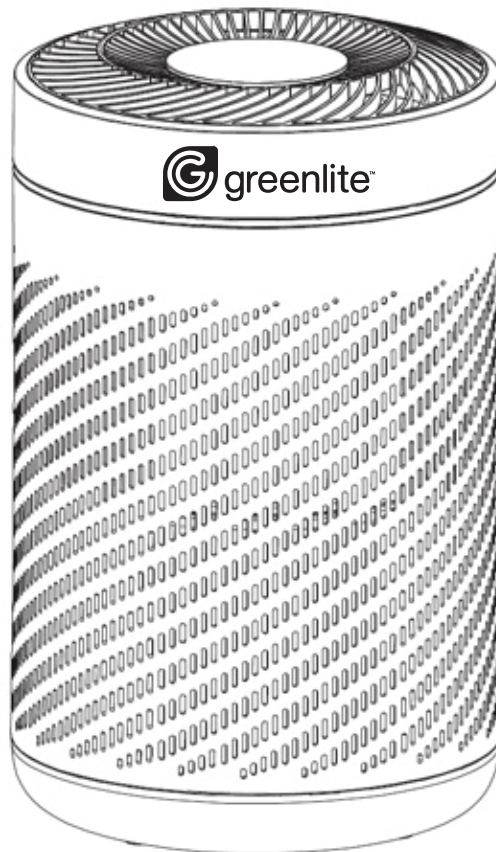

Model No. G-Pure-22W



User Manual Air Purifier



READ AND SAVE THESE INSTRUCTIONS
INSTRUCTION MANUAL AND WARRANTY INFORMATION



Model No. G-Pure-22W

IMPORTANT SAFETY INSTRUCTIONS:

IN ORDER TO AVOID ANY DAMAGE TO YOU, OTHERS, OR PROPERTY, PLEASE FOLLOW THE FOLLOWING SAFETY PRECAUTIONS:

If the power cord or unit does not work, contact Greenlite customer service immediately.

READ ALL INSTRUCTIONS BEFORE USING.

WARNING – TO REDUCE THE RISK OF BURNS, FIRE, ELECTRIC SHOCK, OR INJURY TO PERSONS:

- Unplug or disconnect the air purifier from the power supply if the plug is not working.
- This appliance has a polarized plug (one blade is wider than the other). To reduce the risk of electric shock, this plug is intended to fit in a polarized outlet only one way. If the plug does not fit fully in the outlet, reverse the plug. If it still does not fit, contact a qualified electrician. Do not attempt to defeat this safety feature.
- DO NOT touch the power plug with wet hands.
- Turn off the power before cleaning the unit.
- DO NOT take apart or modify the unit without authorization.
- BEFORE USING THIS PRODUCT, PLEASE MAKE SURE TO REMOVE THE PLASTIC COVERING FROM THE FILTER.
- Indoor and household use only.
- DO NOT place other items on top of the appliance. Sitting or standing on this appliance is forbidden.
- DO NOT insert the fingers or objects into the air inlets or air outlets to prevent the product from physical damages or malfunction.
- This appliance cannot replace natural ventilation and other appliances like the vacuum cleaner, kitchen ventilator, etc.
- When the appliance is working, it must be placed on a dry, flat and stable floor, with at least 50cm space reserved around it.
- DO NOT put it in a place with direct sunlight.
- To prevent electromagnetic disturbance, the appliance must keep a certain distance from the TV, radio, microwave oven and others.
- **WARNING:** To reduce the risk of fire or electric shock, do not use this fan with any solid-state speed control device.

This product employs overload protection (fuse). A blown fuse indicates an overload or short-circuit situation. If the fuse blows, unplug the product from the outlet. Replace the fuse as per the user servicing instructions (follow product marking for proper fuse rating) and check the product. If the replacement fuse blows, a short-circuit may be present and the product should be discarded or returned to an authorized service facility for examination and/or repair.

Do not run cord under carpeting. Do not cover cord with throw rugs, runners, or similar coverings. Do not route cord under furniture or appliances. Arrange cord away from traffic area and where it will not be tripped over.

If the supply cord is damaged, it must be replaced by the manufacturer, its service agent or similarly qualified persons in order to avoid any type of hazard. Children shall not play with the appliance. Cleaning and maintenance of the unit shall not be made by children without supervision. Prior to cleaning or doing any type of maintenance, the appliance must be disconnected from the supply.

SAVE THESE IMPORTANT INSTRUCTIONS FOR EASY REFERENCE.

Model No. G-Pure-22W

TECHNICAL DATA

- Voltage: 120V AC 60Hz
- Power Rating: 22W
- Noise level: 22-55 dB(A)
- Room size: up to 225 sq. ft.
- Unit dimensions: 9.45"W x 9.45"D x 15.04"H
- Unit weight: 6.17 lbs.

PRODUCT INFORMATION

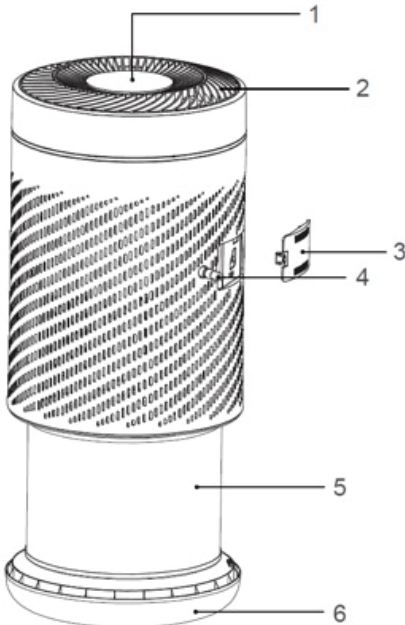

No.	Description
1	Display Screen
2	Air Outlet Grill
3	Back Cover Plate
4	Adapter Cable
5	HEPA Filter
6	Base Plate



Model No. G-Pure-22W

INSTALLATION STEPS



1. Place the unit in a dry location and on a flat surface. To ensure enough ventilation, make sure that there is a 20" (50 cm) distance between the unit and the wall or nearby furniture. This will promote enough ventilation and high efficiency.

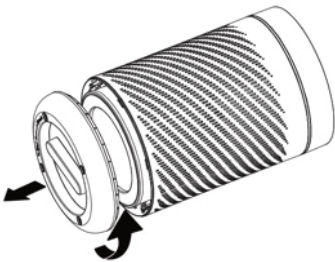

2. Rotate the base counter-clockwise.

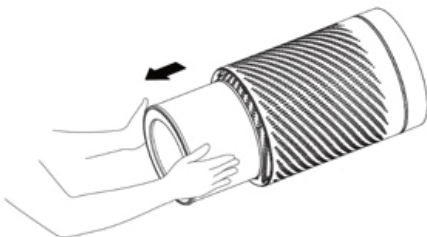

3. Take out the preinstalled HEPA filter.

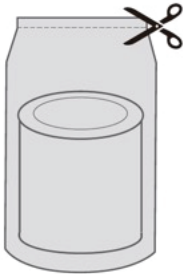

4. Remove the plastic covering from the filter.

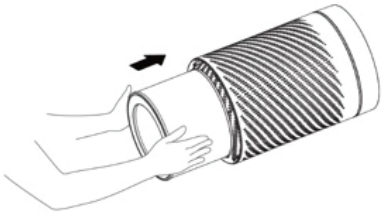

5. Install the new HEPA filter back in the unit.

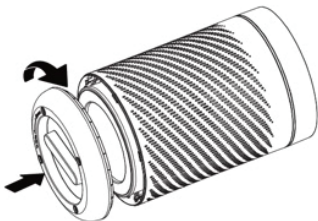

6. Reattach the base at the bottom of the unit (with the filter inside). Rotate the base clockwise to secure it.

Model No. G-Pure-22W

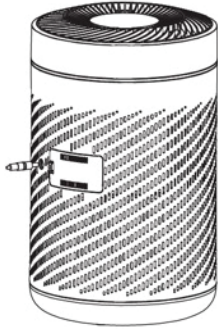

7. Insert the adapter cable into the air purifier.

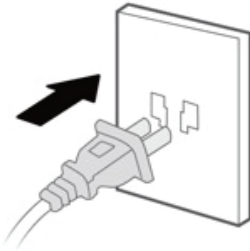

8. Insert the plug into a power source.

ATTENTION



Remove all plastic packaging from the filter before installing it.
DO NOT run the air purifier if there is no filter installed.
Please be careful when installing the back cover. Watch your hands.



9. Insert the plug into a power source. Unit lights will flash for 1 second. Unit lights will turn off and the air purifier will be in standby mode.

Model No. G-Pure-22W

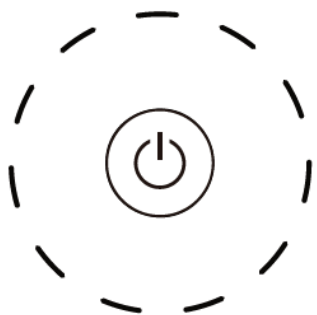

10. Press the On / Standby Button



11. The air quality sensor will be in the warm up stage and the air quality indicator will flash for 3 seconds.



12. The air purifier will enter into the Auto Mode when it is powered for the first time.

Model No. G-Pure-22W

CONTROL PANEL

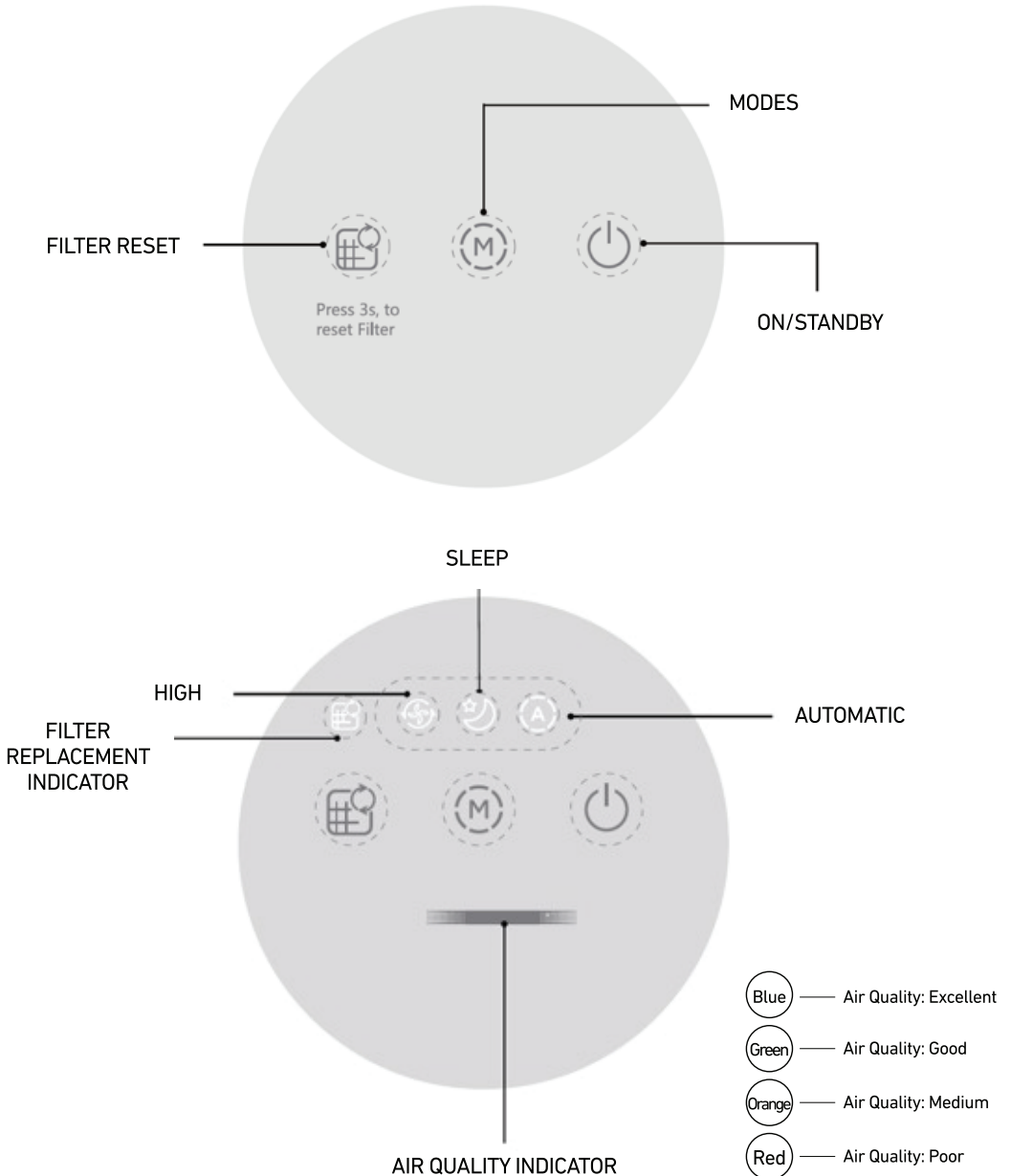

Model No. G-Pure-22W

CLEANING AND MAINTENANCE

Disconnect the power plug before cleaning the unit. Do not put the unit in water or in any other liquid. Do not use abrasive, corrosive or flammable products to clean any parts of the unit. Filters cannot be washed.

CLEANING THE AIR PURIFIER

Cleaning the housing and inlet of the air purifier

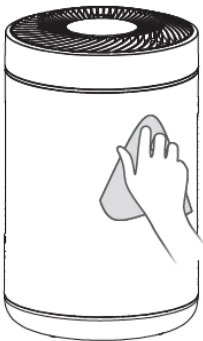

Use a soft and dry cloth to remove the dust from the air purifier.

Cleaning the inside of the air purifier

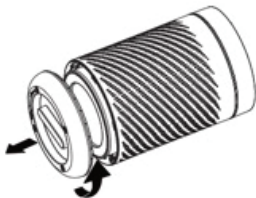
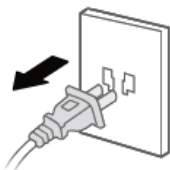

Turn off the power, rotate the base counter-clockwise and take out the HEPA filter. Use a soft and dry cloth to clean the inside of the air purifier.

Model No. G-Pure-22W

Cleaning the outlet of the air purifier

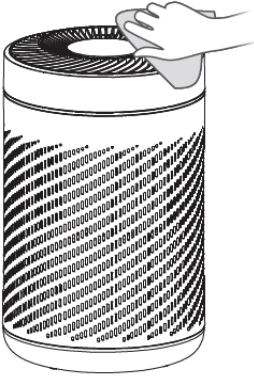

Use a soft and dry cloth to clean the outlet of the air purifier.

CLEANING THE FILTER

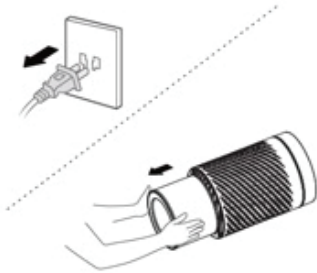

1. Turn off the power and take out the HEPA filter.



2. Use a soft and dry cloth to clean the filter.

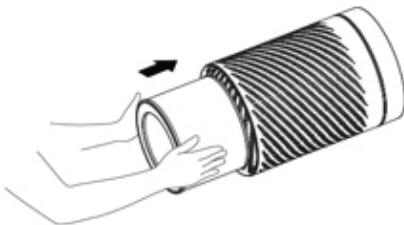

3. Reattach the base at the bottom of the unit with the filter inside. Rotate the base counter-clockwise to secure it.

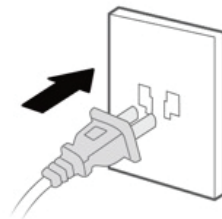

4. Insert the plug into a power source.

Model No. G-Pure-22W

FILTER REPLACEMENT

LIGHT INDICATOR TO REPLACE THE FILTER

The unit will remind the user when the filter is due to be replaced.

Filters should be replaced every 3-6 months depending on usage. The filter change indicator light will let you know when you have reached that time.



The filter change indicator light will alert the user when the filter is due to be replaced.

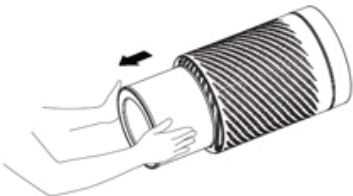

Remove old filter and replace with only a Greenlite G-Pure-22W HEPA filter.



Press and hold the filter change button for 3 seconds to reset the HEPA filter.

Model No. G-Pure-22W

User Servicing Instructions

1.1. Remove plug from the receptacle or other outlet device. Do not unplug by pulling on cord.

1.2. Open fuse cover.

Slide open fuse access cover on top of attachment plug towards blades. (Fig.①)

1.3. Remove fuse carefully.

Insert the tip of your tool into fuse slot (close with the terminal), then loosen the fuse gradually and slowly, but not overexert. If you feel tight, you can try it at several times and loosen the fuse little by little. Once the fuse is loose, then you can get the fuse out entirely. (Fig.②)

1.4. Risk of fire.

Replace fuse only with 2.5 Amp, 125 Volt fuse. (Fig.③)

1.6 Risk of fire.

Do not replace attachment plug. Contains a safety device (fuse) that should not be removed. Discard product if the attachment plug is damaged.

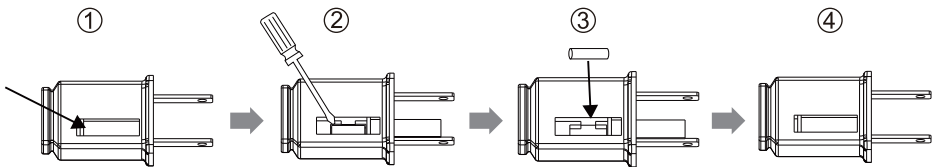

WARRANTY:

This product is warranted to be free from defects in workmanship and material for 1 year. If it fails to do so, Greenlite™ will, at its election, provide a replacement or equivalent upon receipt of the register receipt and proof of purchase. Please visit www.greenliteusa.com to find out how to initiate a warranty claim. This limited warranty does not cover bulbs subject to accident, neglect, abuse, misuse or acts of God. Replacement or refund is your sole remedy.

For all inquiries, please contact our customer service team at:
info@greenliteusa.com or 1-844-695-9090 from 9:00 AM to 5:00 PM EST.