

Model NO: 10.5W/T8/4A/50K

10.5W LED T8 Linear Tube

Ballast Compatible - Type A or Plug & Play

INSTALLATION GUIDE – WARNING

- **DANGER:** Risk of shock-disconnect power before installation.
- **WARNING:** Risk of fire or electric shock. LED Retrofit Kit installation requires knowledge of luminaire electrical systems. If not qualified, do not attempt installation. Contact a qualified electrician.
- **WARNING:** Product must be installed in accordance with the national electrical code or your local electrical code. If you are not familiar with these codes and requirements, contact a qualified electrician.
- **WARNING:** Install this kit only in luminaires that have the construction features and dimensions shown in the photographs and/or drawing and where the input rating of the retrofit kit does not exceed the input rating of the luminaire.
- **WARNING:** To prevent wiring damage or abrasion, do not expose wiring to edges of sheet metal or other sharp objects. Do not make or alter any open holes in any enclosure of wiring or electrical components during kit installation.
- **WARNING:** This lamp only operates on electronic ballasts.
- Do not use with dimmers
- Suitable for dry and damp locations.
- This device is not intended for use with emergency exits.
- This device complies with part 15 of the FCC rules

INSTALLATION INSTRUCTIONS:

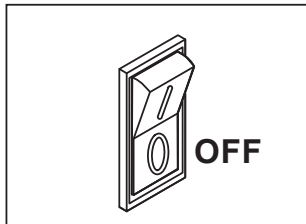

1. Turn power off

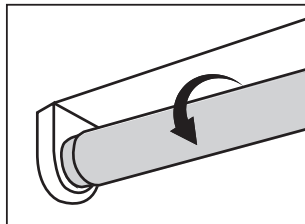

2. Remove lens or diffuser if applicable. Remove existing fluorescent lamp(s) from luminaire. Note: Verify that the fluorescent tube type is listed on the LED lamp label.

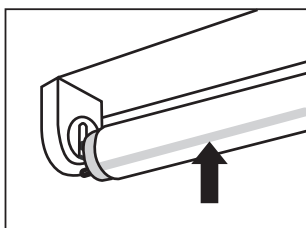
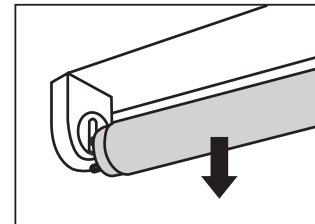

3. Install LED lamp (one for each fluorescent lamp removed, ensure pins are firmly seated in lampholders). Place Lens or diffuser back in place if applicable.

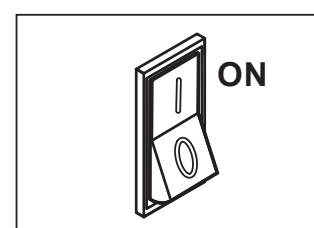
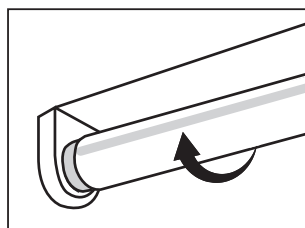

4. Turn on power on.

CAUTION - IF THE LAMP OR LUMINAIRE EXHIBITS UNDESIRABLE OPERATION (BUZZING, FLICKERING, ETC.), IMMEDIATELY TURN OFF POWER, REMOVE LAMP FROM LUMINAIRE AND CONTACT THE MANUFACTURER.

LIMITED WARRANTY: This product is warranted to be free from defects in workmanship and material for 5 years. If it fails to do so, Greenlite™ will send you, at its election, a replacement product or refund your original purchase price upon receipt of the returned fixture, register receipt and proof of purchase. Please call (844) 695-9090 to find out how to return the product. Do not return this product to the retailer. This limited warranty does not cover product subject to accident, neglect, abuse, misuse or acts of God. Replacement or refund is your sole remedy.

Model NO: 10.5W/T8/4A/50K

10.5W LED T8 Linear Tube

Ballast Compatible - Type A or Plug & Play

Installation wiring diagram:

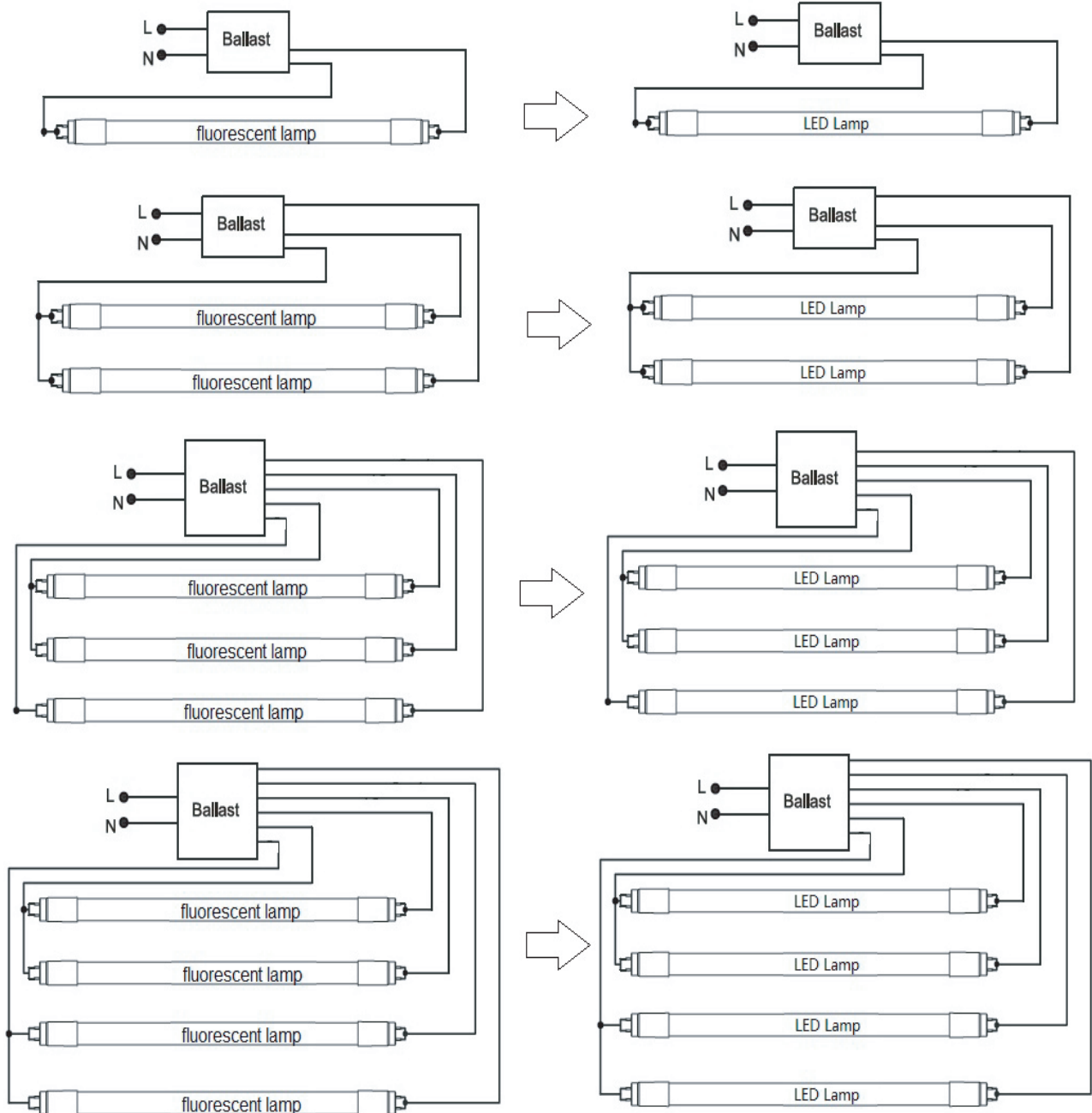

LIMITED WARRANTY: This product is warranted to be free from defects in workmanship and material for 5 years. If it fails to do so, Greenlite™ will send you, at its election, a replacement product or refund your original purchase price upon receipt of the returned fixture, register receipt and proof of purchase. Please call (844) 695-9090 to find out how to return the product. Do not return this product to the retailer. This limited warranty does not cover product subject to accident, neglect, abuse, misuse or acts of God. Replacement or refund is your sole remedy.