

Tier 1 Advanced Power Strip

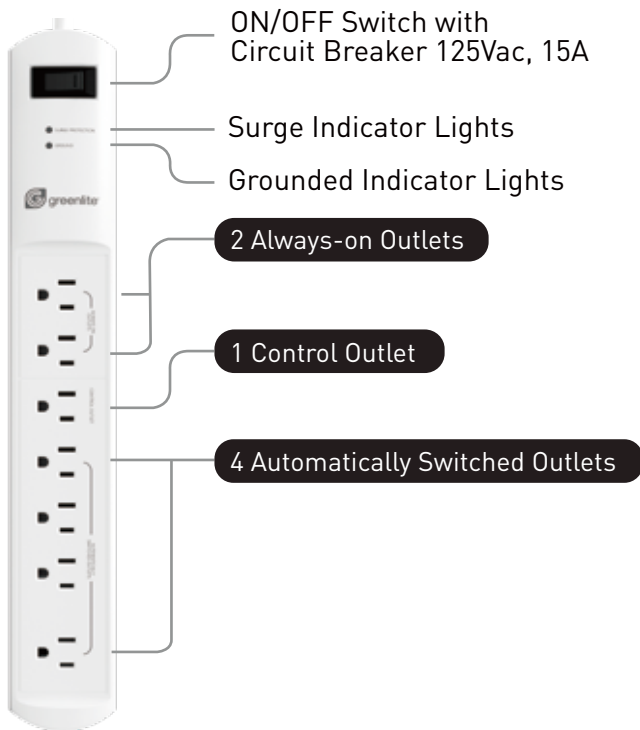

WARNING

For indoor use in dry locations. Not intended for use with aquarium equipment. Combined load used on all the outlets at any one time must not exceed 1800 watts. In case of overloading, the circuit breaker will safely shut off all power. Eliminate overload, then reset by pressing the circuit breaker switch.

CAUTION

RISK OF ELECTRIC SHOCK, DO NOT PLUG INTO ANOTHER RELOCATABLE POWER STRIP OR AN EXTENSION CORD.

Specification

On/off Resettable Circuit Break	Rated 15A
Max Total Spike Voltage	6000V
Max Total Spike Current	3000A
Clamping Response Time	< 1ns
Standby Power	< 1W
Minimum Control Outlet Switched On Power	12W±2W
Maximum Control Outlet Standby Power	12W

PRODUCT FEATURES

POWER CONNECTIONS

The Tier 1 Advanced Power Strip must be plugged only into a grounded receptacle. All connected devices must be plugged directly into the Tier 1 Advanced Power Strip. Use of an extension cord, adaptor or other power strip in conjunction with the Tier 1 Advanced Power Strip will void all warranties.

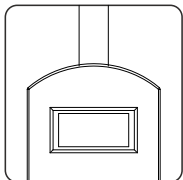

RESETTABLE CIRCUIT BREAKER

Provides protection for all outlets on the Tier 1 Advanced Power Strip. If no devices are powered or no LEDs are lit, press the circuit breaker to reactivate power.

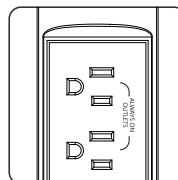

ALWAYS-ON OUTLETS

These outlets stay "on" and are controlled only by the ON/OFF switch. Plug devices that you do not want turned off, such as a fax machine or cordless phone into these outlets.

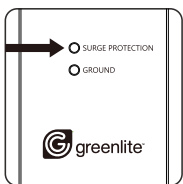

SURGE LED INDICATOR

When it is illuminated, it indicates that the surge protection is functioning normally. If this is not illuminated, the Tier 1 Advanced Power Strip must be replaced.

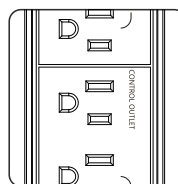

CONTROL OUTLET

This outlet controls the AUTOMATICALLY SWITCHED outlets. Plug a computer or TV into this outlet.

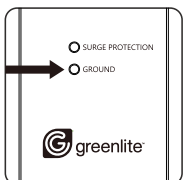

GROUND LED INDICATOR

When it is illuminated, it indicates that the Tier 1 Advanced Power Strip is correctly grounded. If it is not illuminated, there is a grounding problem and you should contact an electrician to properly ground the socket. Connecting a Tier 1 Advanced Power Strip to an improperly grounded receptacle will void all warranties.

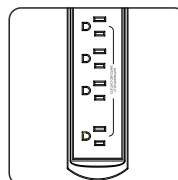

AUTOMATICALLY SWITCHED OUTLETS

These outlets are automatically controlled by the CONTROL OUTLET. Plug in peripheral devices such as a monitor, printer and DVD player into these outlets.

LIMITED WARRANTY: This product is warranted to be free from defects in workmanship and material for 2 years. If it fails to do so, Greenlite™ will at its election, provide a replacement or equivalent upon receipt of the register receipt and proof of purchase. Please visit www.greenliteusa.com to find out how to initiate a warranty claim. For all customer service queries, please contact our customer service team, Monday-Friday at info@greenliteusa.com or call 1-844-695-9090 from 9:00 AM to 5:00 PM (EST). This limited warranty does not cover fixtures subject to accident, neglect, abuse, misuse or acts of God. Replacement or refund is your sole remedy.

Tier 1 Advanced Power Strip

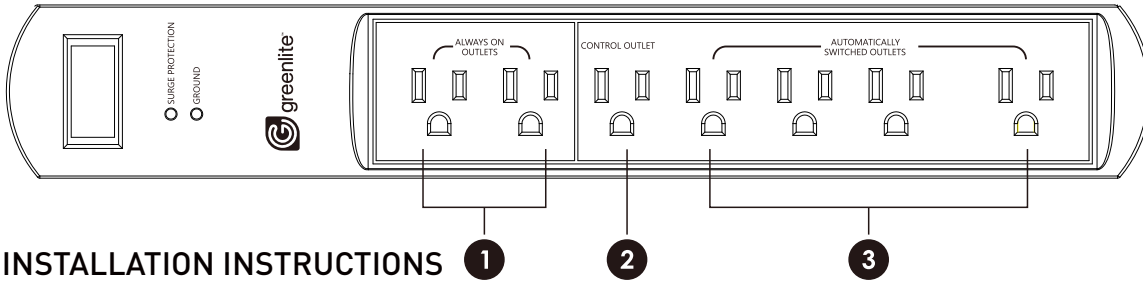

View a short video on how to install your 7 Outlet Advanced Power Strip by going to BIT.LY/GREENLITEAPS7 or scan this QR code with your phone:



INSTALLATION INSTRUCTIONS

1) ALWAYS ON OUTLETS

Two (2) outlets controlled only by the ON/OFF switch and not by the Control Outlet. Plug in device (Fax machine, cordless phone, cable box or satellite receiver) that you do not want turned off.

2) CONTROL OUTLET

Controls the other four (4) energy saving outlets. Plug the main controlling device (Computer or TV) into this outlet. When the main controlling device is set to off, the Tier 1 Advanced Power Strip will automatically turn off any devices plugged into the Automatically Switched Outlets.

3) AUTOMATICALLY SWITCHED OUTLETS

Four (4) outlets controlled by the energy saving Control Outlet. Plug in peripheral devices (Printer or DVD player) into these outlets. These peripheral devices will be automatically controlled by the main controlling device plugged into the Control Outlet.

Plug the Tier 1 Advanced Power Strip power cord into a properly grounded wall outlet and then press the red ON/OFF switch to the RESET (on) position. The GROUND and SURGE PROTECTION lights should be illuminated, indicating that the circuit is functioning properly.

If the peripheral device(s) plugged into the AUTOMATICALLY SWITCHED OUTLETS do not turn on:

- Make sure the device plugged into the CONTROL OUTLET is ON.
- Turn "off" the device plugged into the CONTROL OUTLET. If the AUTOMATICALLY SWITCHED OUTLETS turn "off", then you are done.

TV SETUP

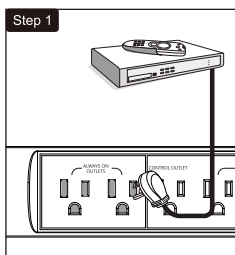

Plug in devices that require constant power (cable box) into the outlets labeled "ALWAYS ON OUTLETS".

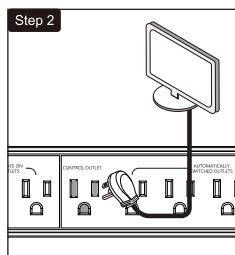

Plug the TV into the outlet labeled "CONTROL OUTLET".

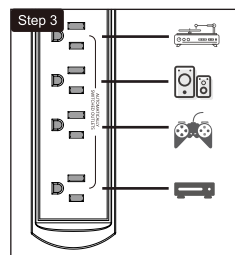

Plug in TV peripheral electronics (AV receiver, DVD player, etc.) into the outlets labeled "AUTOMATICALLY SWITCHED OUTLETS".

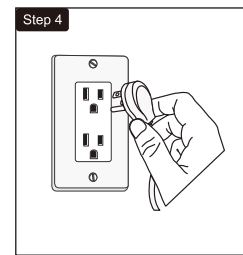

Plug the power strip into a grounded wall receptacle.

PC SETUP

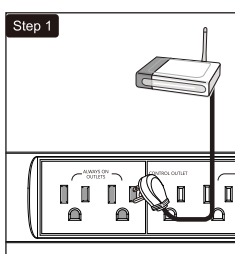

Plug in devices that require constant power (Modem, router, etc.) into the outlets labeled "ALWAYS ON OUTLETS".

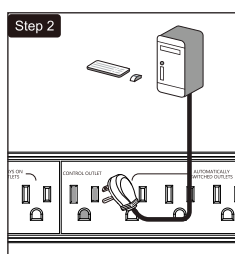

Plug the PC into the outlet labeled "CONTROL OUTLET".

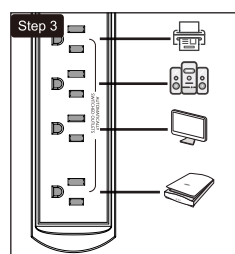

Plug in TV peripheral electronics (Printer, monitor, speakers, etc.) into the outlets labeled "AUTOMATICALLY SWITCHED OUTLETS".

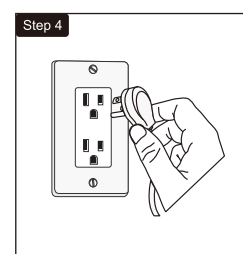

Plug the power strip into a grounded wall receptacle.