

LED Globe Fixture

IMPORTANT General Safety Information

READ AND FOLLOW SAFETY INSTRUCTIONS - DISCONNECT POWER BEFORE INSTALLATION

WARNING:

Carefully read these instructions before beginning installation. Failure to do so could lead to electric shock, fire, or other injuries which could be hazardous or even fatal.

CAUTION: To reduce the risk of fire, electric shock, or injury:

- Use only insulated staples or plastic ties to secure cords.
- Route and secure cords so that they will not be pinched or damaged.
- Match the wide blade of the plug to the wide slot and fully insert into the outlet.

The National Electrical Code (NEC) does not permit cords to be concealed where damage to insulation may go unnoticed. To prevent fire danger, do not run cord behind walls, ceilings, soffits, or cabinets where it may be inaccessible for examination. Cords should be visually examined periodically and immediately replaced when any damage is noted.

Pre-Installation

If you are unfamiliar with electrical installations, we recommend you contact a qualified electrician to do the installation. Before beginning installation or operation of product make sure all the parts below are present.

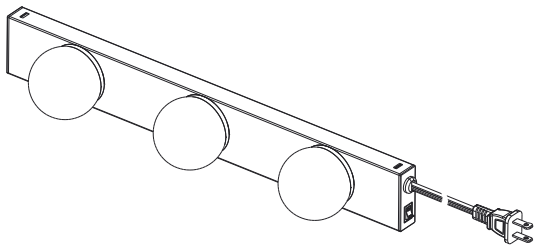

(A) 16" LED Vanity Light

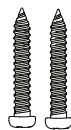

(BB) 2x Screws

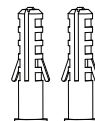

(CC) 2x Drywall Anchors



(DD) 2x Double-sided Tape

LED Globe Fixture

INSTALLATION:

1. Identify the desired location for the LED Globe Fixture to make sure the length of the fixture fits.
2. Installing the LED Globe Fixture:

OPTION 1 (Screws):

Install two screws (BB) on the mounting surface spaced 5.5" apart. Leave approximately 0.1" between the surface and screw. (Recommend to use screws with wall anchors (CC) if mounting onto plaster board).

Recommended Tools:



Philips
screwdriver



Measuring
tape

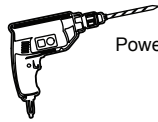

Power drill

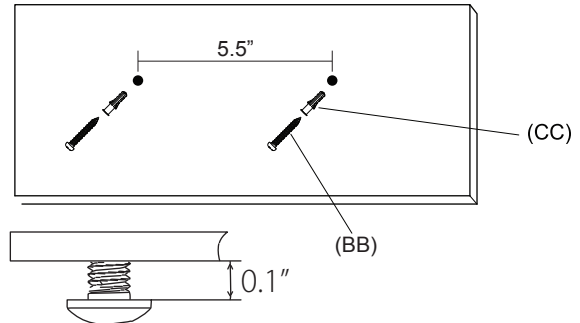

Align the LED Globe Fixture to the screws and slide to one side to secure it in place. The LED Globe Fixture should be firmly fixed against the screws. If not firmly fixed, remove the fixture and tighten the screws to a smaller gap distance to the surface.

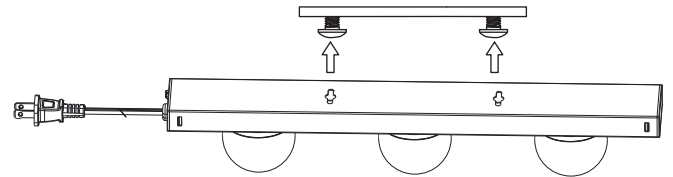

OPTION 2 (Double-sided tape):

For double-sided tape installation, place the double-sided tape (DD) on the LED Globe Fixture. Remove the backing of the double-sided tape and press lightly to install on the mounting surface.

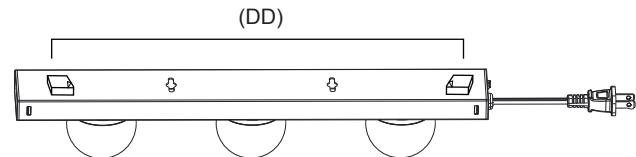

3. Plug the LED Globe Fixture into 120V, 60Hz outlet and turn on the switch.

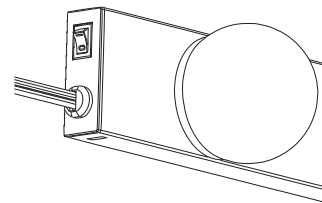

Care & Cleaning

CAUTION: Before attempting to clean the fixture, turn off the switch and unplug the fixture from the wall outlet.

- Clean the fixture with a soft, dry cloth.
- Do not use cleaners with chemicals, solvents, or harsh abrasives.
- Do not use liquid cleaner on the LEDs, LED driver, or wiring inside the light fixture.

LIMITED WARRANTY:

This fixture is warranted to be free from defects in workmanship and material for 5 years. If it fails to do so, Greenlite™ will, at its election, provide a replacement or equivalent upon receipt of the register receipt and proof of purchase. Please visit www.greenliteusa.com to find out how to initiate a warranty claim. For all customer service queries, please contact our customer service team, Monday-Friday at info@greenliteusa.com or call 1-844-695-9090 from 9:00 AM to 5:00 PM (EST). This limited warranty does not cover fixtures subject to accident, neglect, abuse, misuse or acts of God. Replacement or refund is your sole remedy.